

Article number: 2310431050

Description: E+G Levelling elements
LX.40-SW17-M12X100

Measures

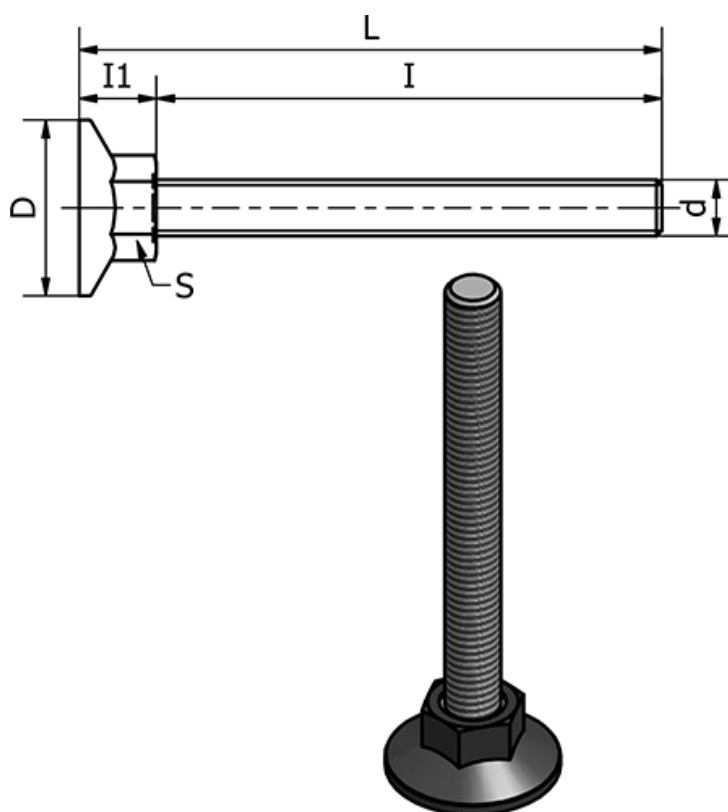

d	= M12
D	= 40
I	= 100
I1	= 13
L	= 112.5
S	= 17
Static load in (N)	= 5000
Type	= Forzinket

Weight (g) = -